

# Kezelési útmutató tolóajtós zuhanykabinhoz - HU



**Homedepo Paris tolóajtós zuhanykabin**  
**6 mm vastag vízlepergető biztonsági üveggel**



## Tudnivalók

- Átlagos tisztítószer és puha kendő segítségével tisztítható, elkerülve az ammóniát és acetont tartalmazó szereket.
- Ne használjon durva felületű tisztítóeszközt, illetve súrolószert a tisztításához.
- Ne használjon tompa vagy éles tárgyat a kabin használatakor, amik esetlegesen összekarcolhatják a felületét.
- Tárolás közben ne fordítsa meg, ne tegyen rá másik terméket, és ne tegye a terméket szerves vegyületek közelébe (pl. formaldehid).
- A vásárlás napjától számított 1 év garanciát biztosítunk.
- Ennek az alábbi feltételek esetén fogadjuk a garanciális cserét:

A használatban kopó alkatrészek, - például gumitömítések, vízvetők, görgők.

A garancia nem terjed ki olyan károkra, melynek okai a gondatlanság, nem rendeltetésszerű használat, szakszerűtlen szerelés vagy javítás, tárolási sérülések, a nem megfelelő karbantartás és ápolás, illetve természetes elhasználódás (pl. természetes kopás, elszíneződés, stb.).

Nem érvényes a garancia közvetett károk esetén, ha a hiba nem a termék gyártási hibájára vezethető vissza, pl.: feszültségingadozások, villámcsapás, korrózió, és általában véve minden olyan ok, amely a víz tulajdonságaiból valamint az elektromos és vizes bekötések minőségéből adódik.

Üvegtörésre a garancia nem vonatkozik.

# Installation manual for framed shower enclosure – HU



## Homedepo Paris framed shower enclosure

6 mm thick water-repellent safety glass



## **Precautions**

- Clean with an average detergent and a soft cloth, avoiding agents containing ammonia and acetone.
- Do not use rough surface cleaning tools or abrasives for cleaning.
- Do not use blunt or sharp objects when using the cabin, which may scratch its surface.
- During storage, do not turn it over, do not put another product on it, and do not place the product near organic compounds (e.g. formaldehyde).
- We provide a 1-year warranty from the date of purchase.
- We accept the warranty replacement under the following conditions:

Parts that wear out during use, such as rubber seals, sprinklers, rollers.

The warranty does not cover damage caused by carelessness, improper use, improper installation or repair, storage damage, improper maintenance and care, or natural wear and tear (e.g. natural wear, discoloration, etc.).

The warranty is not valid in case of indirect damages, if the fault cannot be traced back to a manufacturing defect of the product, e.g.: voltage fluctuations, lightning strikes, corrosion, and in general all causes arising from the properties of the water and the quality of the electrical and water connections.

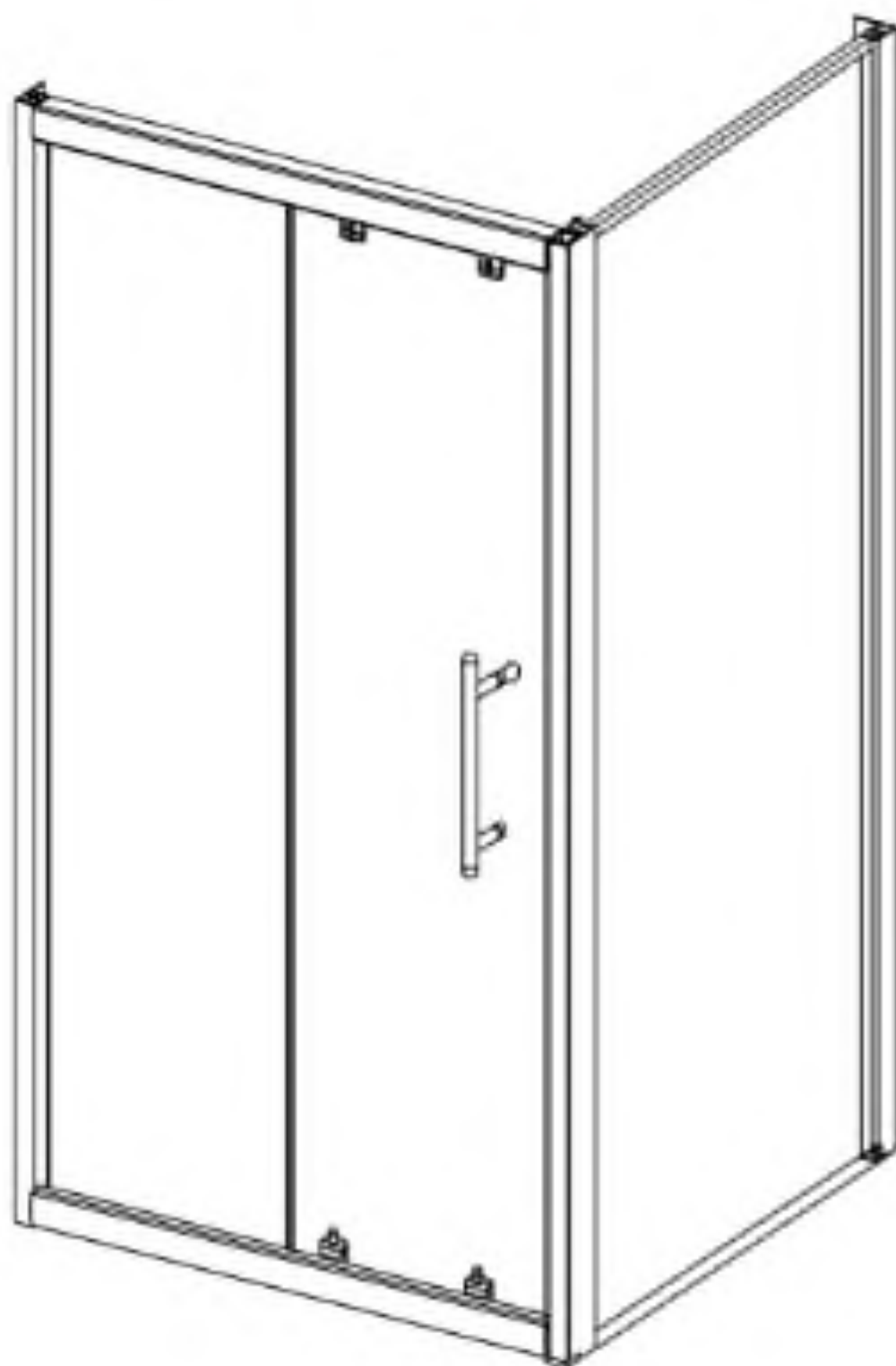

The warranty does not cover breaking the glass.

# Paris

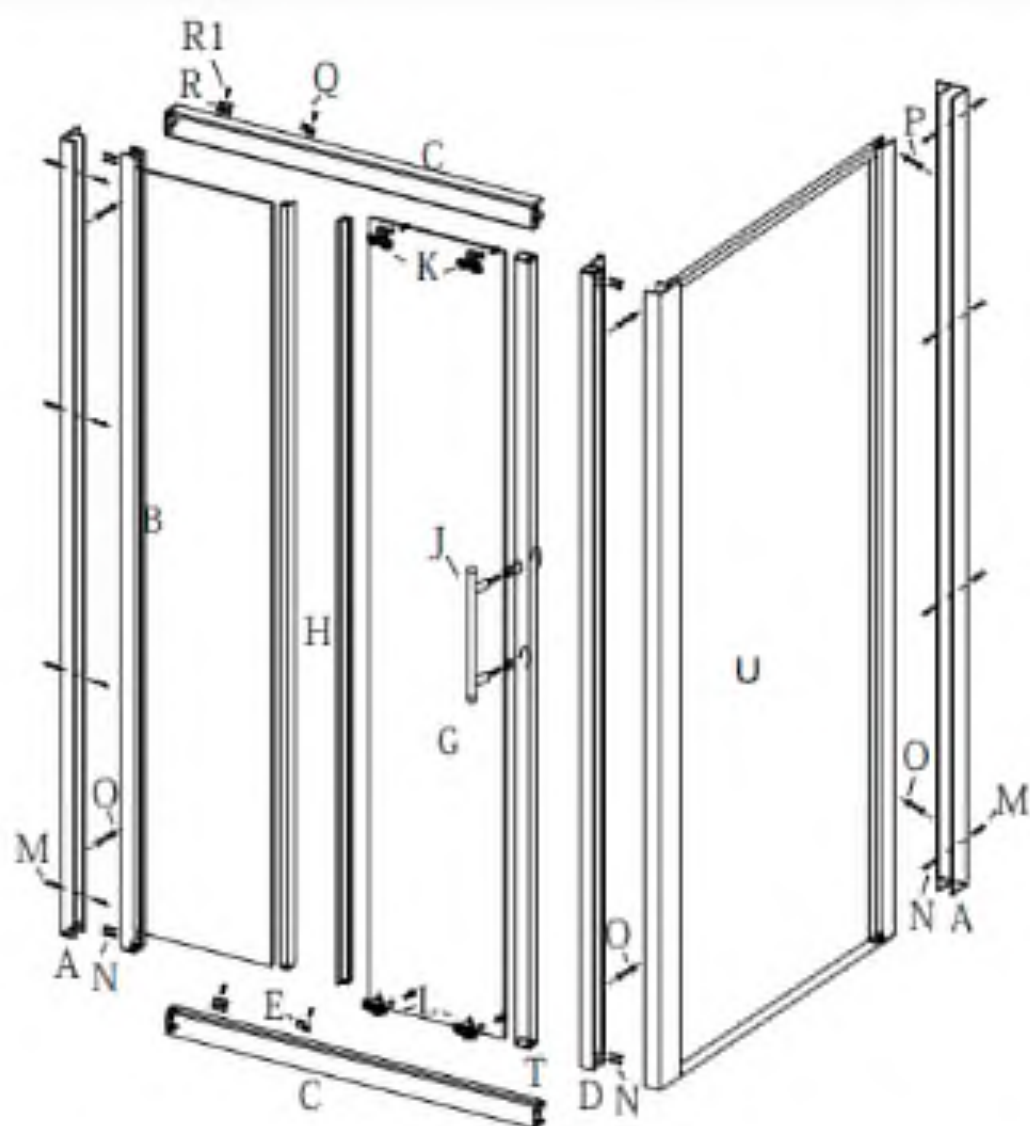





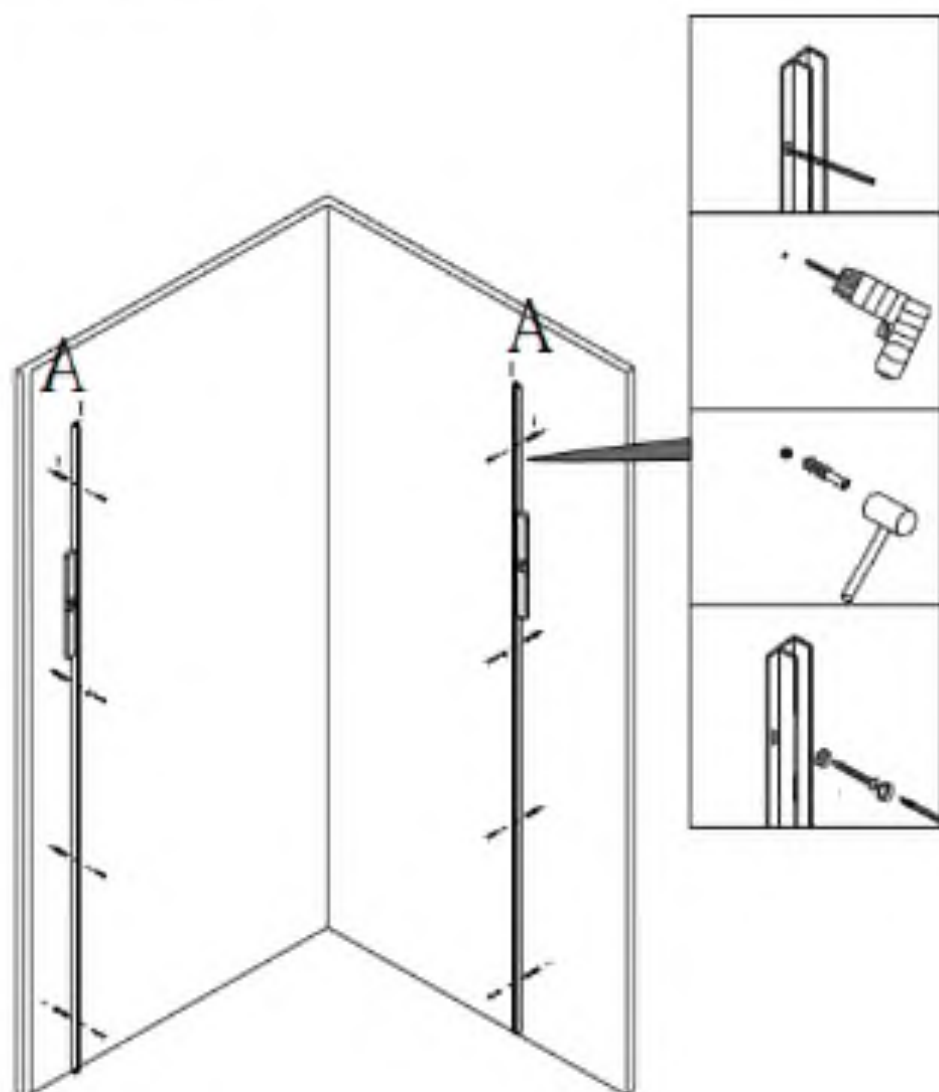

A		2	J		1	Q		M4x12	2
B		1	K		2	R			2
C		2	L		2	R1		M4x10	2
D		1	M		8	T			1
E		2	N		16	U			1
G		1	O		6				
H		2	P		6				

A		2
M		8
N	 M4*30	8



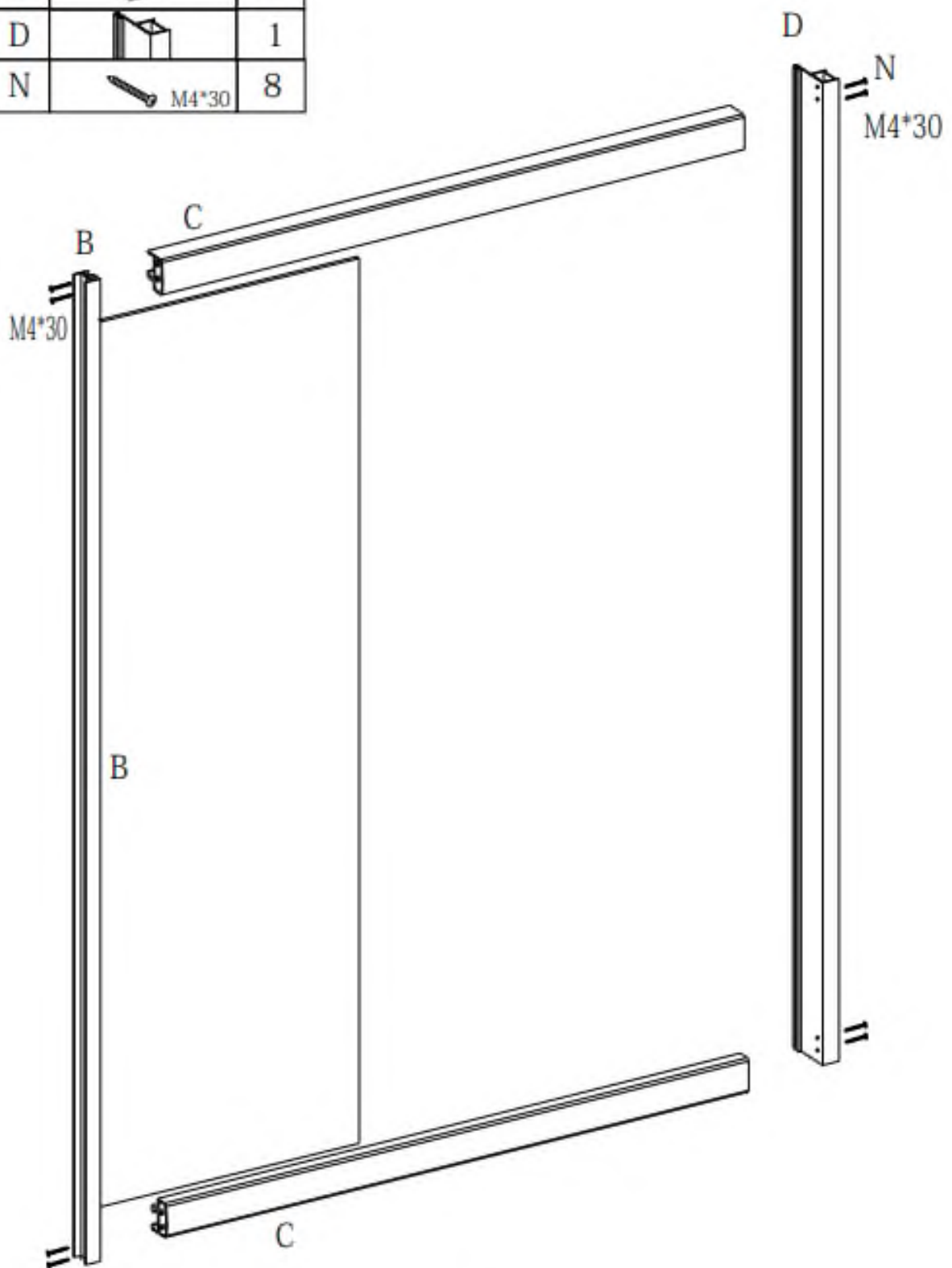

B		1
C		2
D		1
N	 M4*30	8



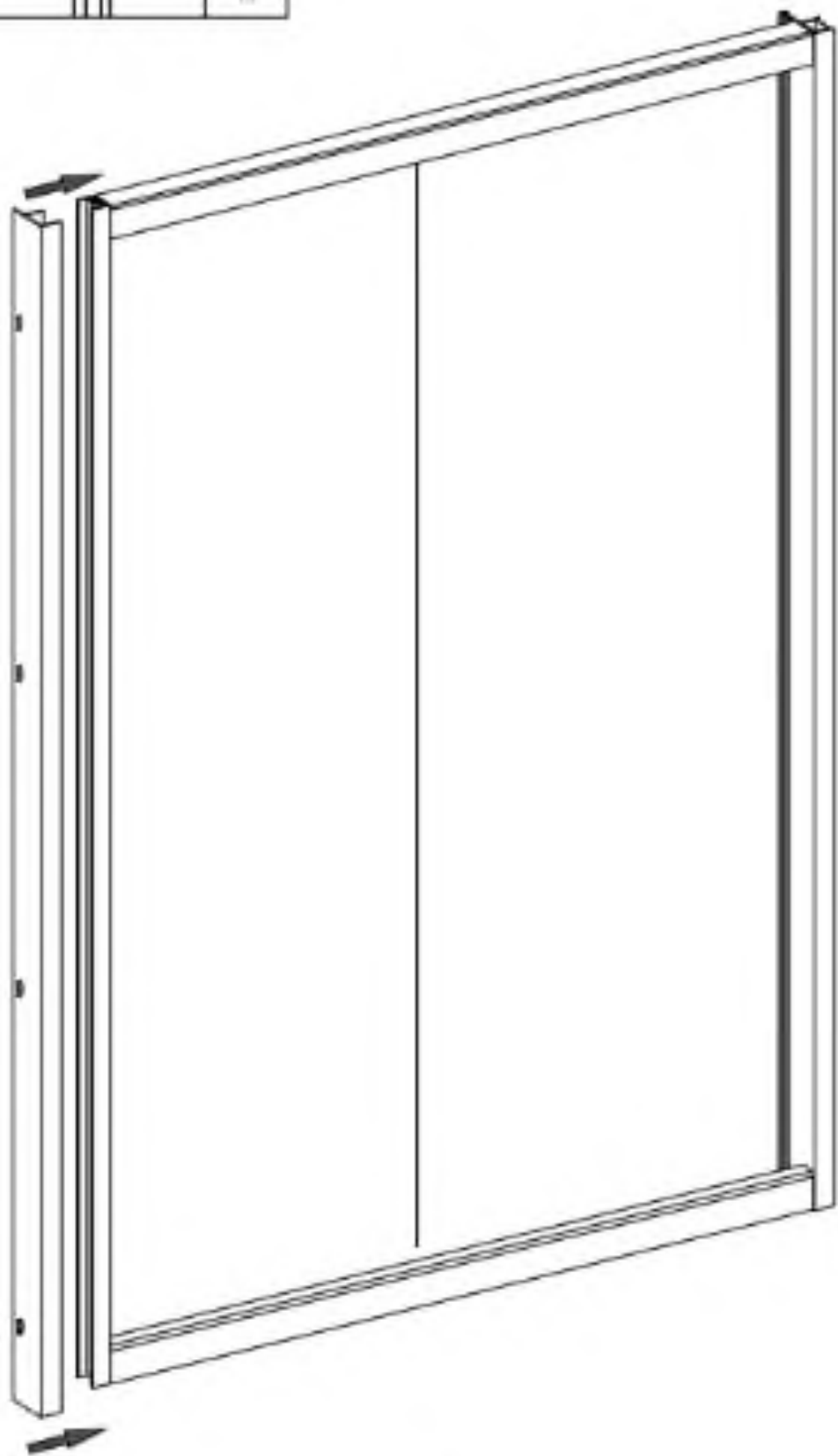
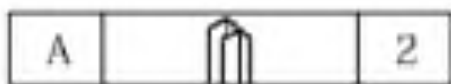

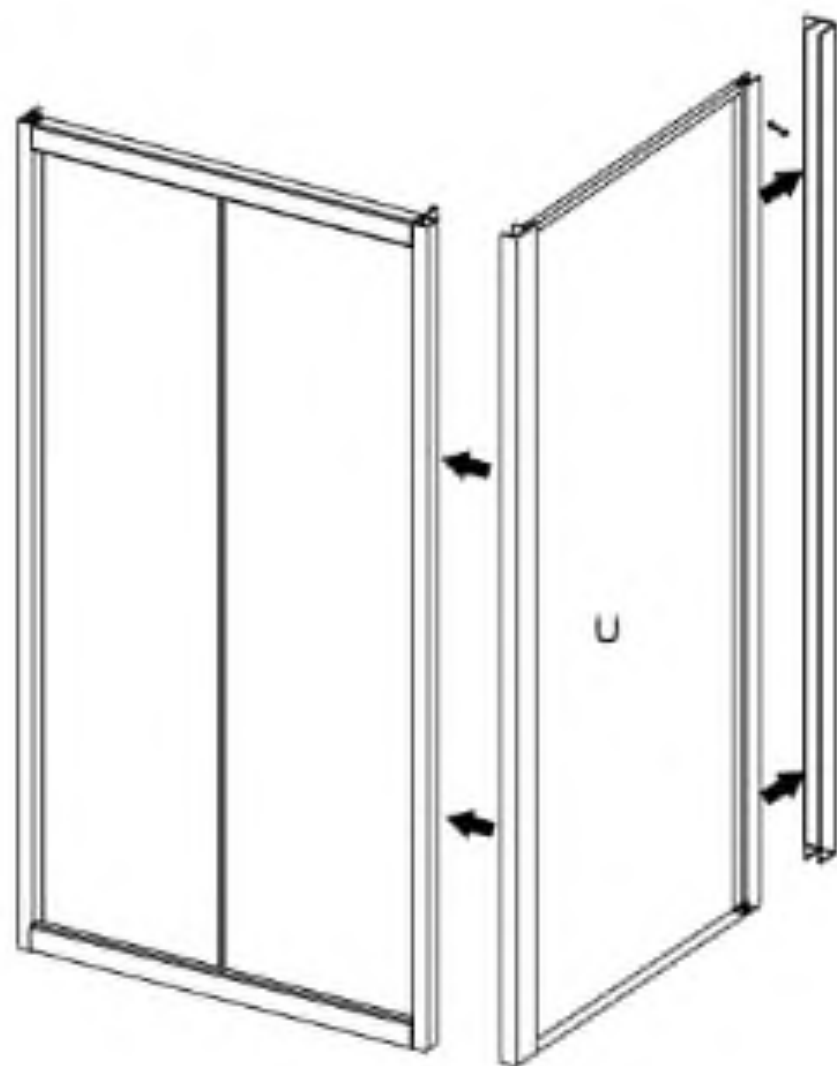





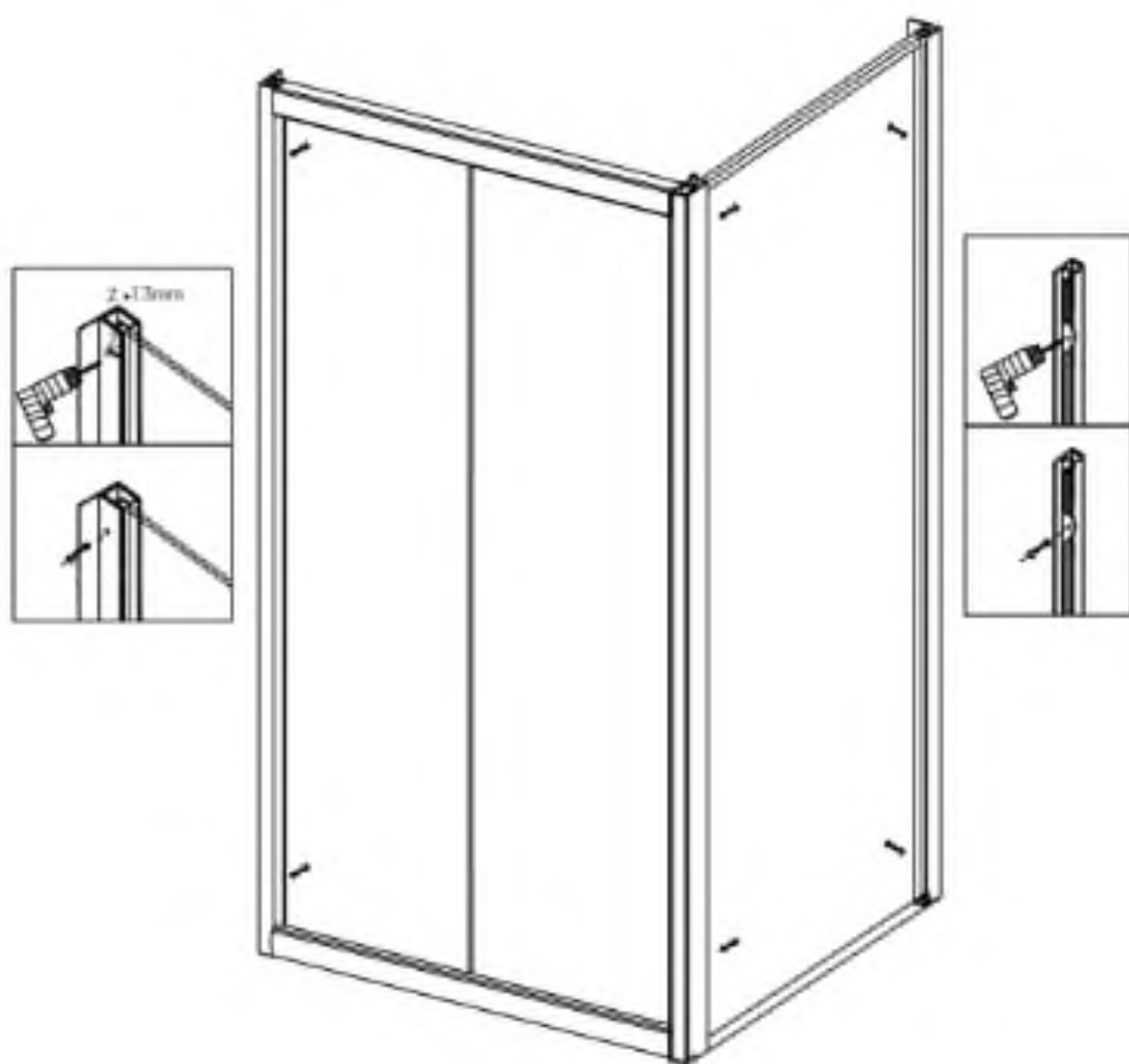

O		6
P	 M4*10	6

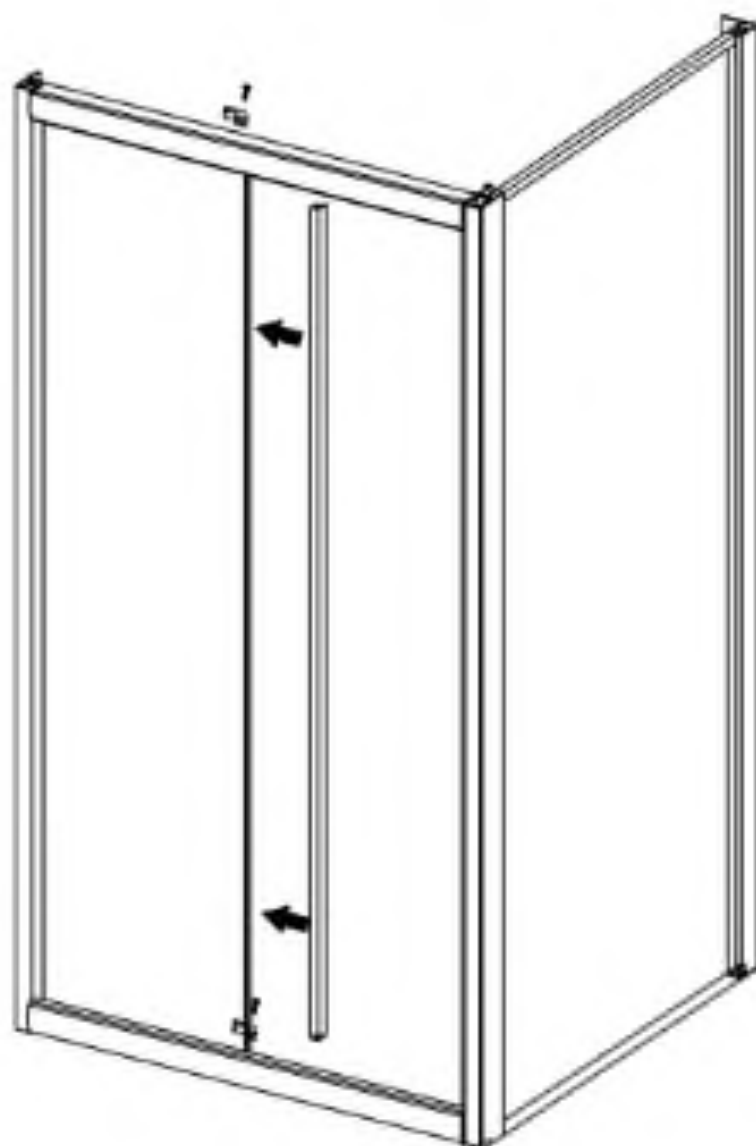





E		2
Q	 M4x12	2
H		1

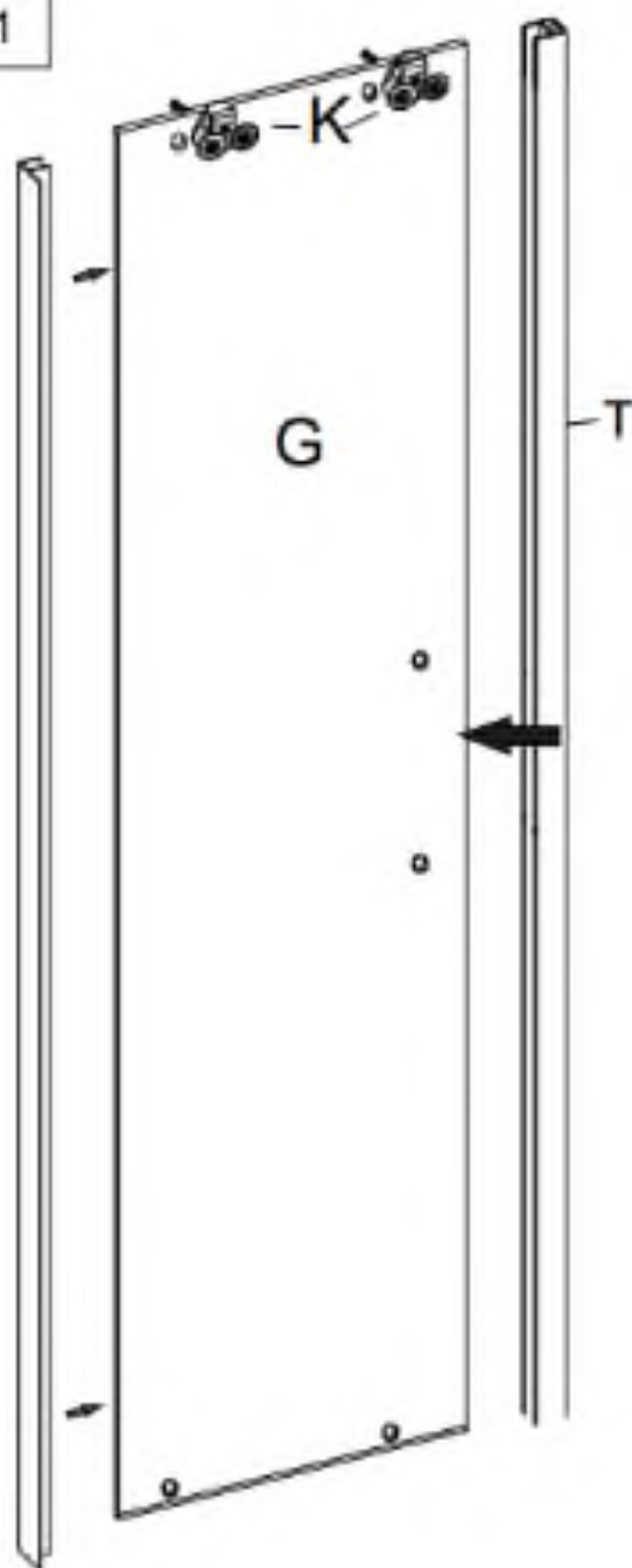

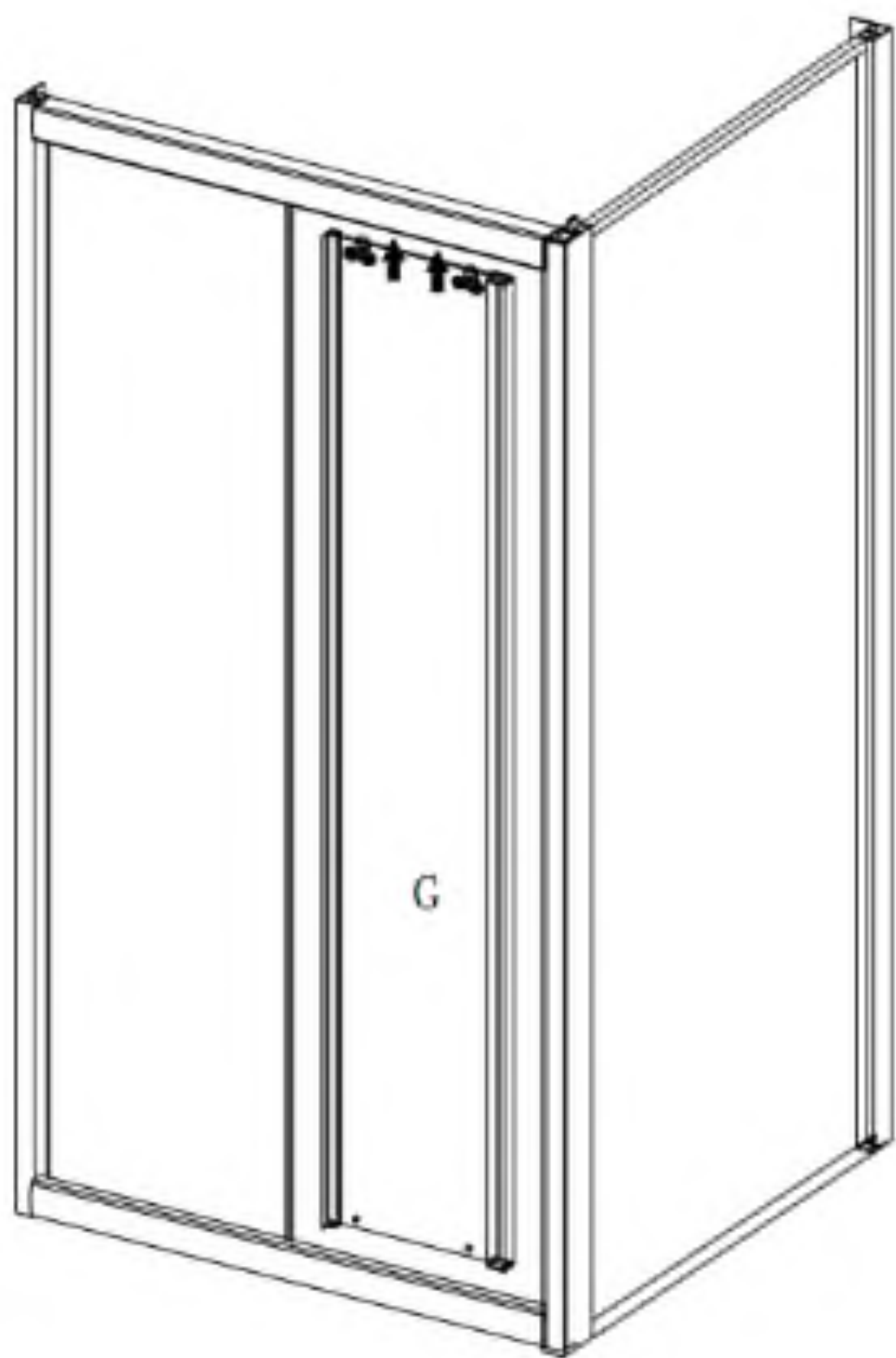
G		1
K		2
H		1
T		1





R		2
RI	 M4x10	2
L		2

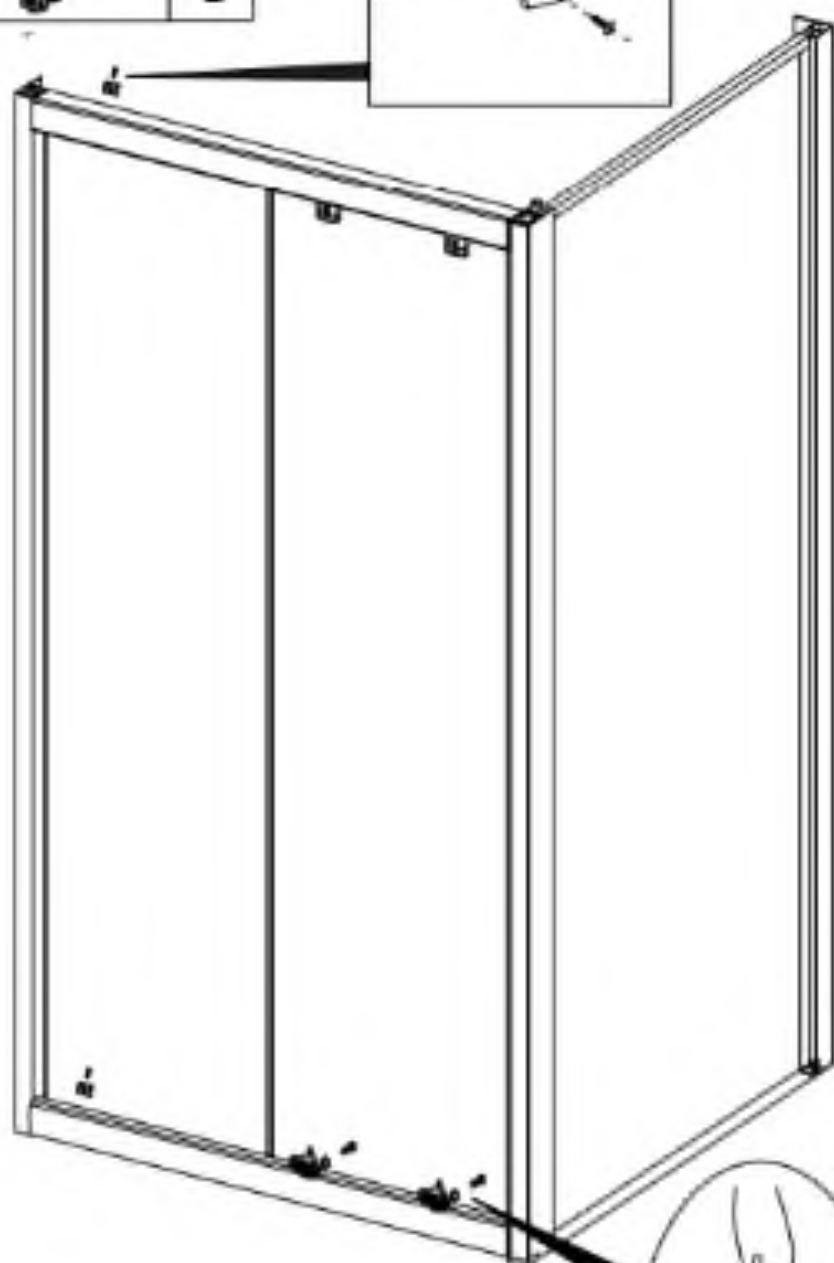
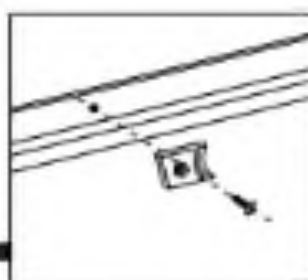

J		1
---	---	---

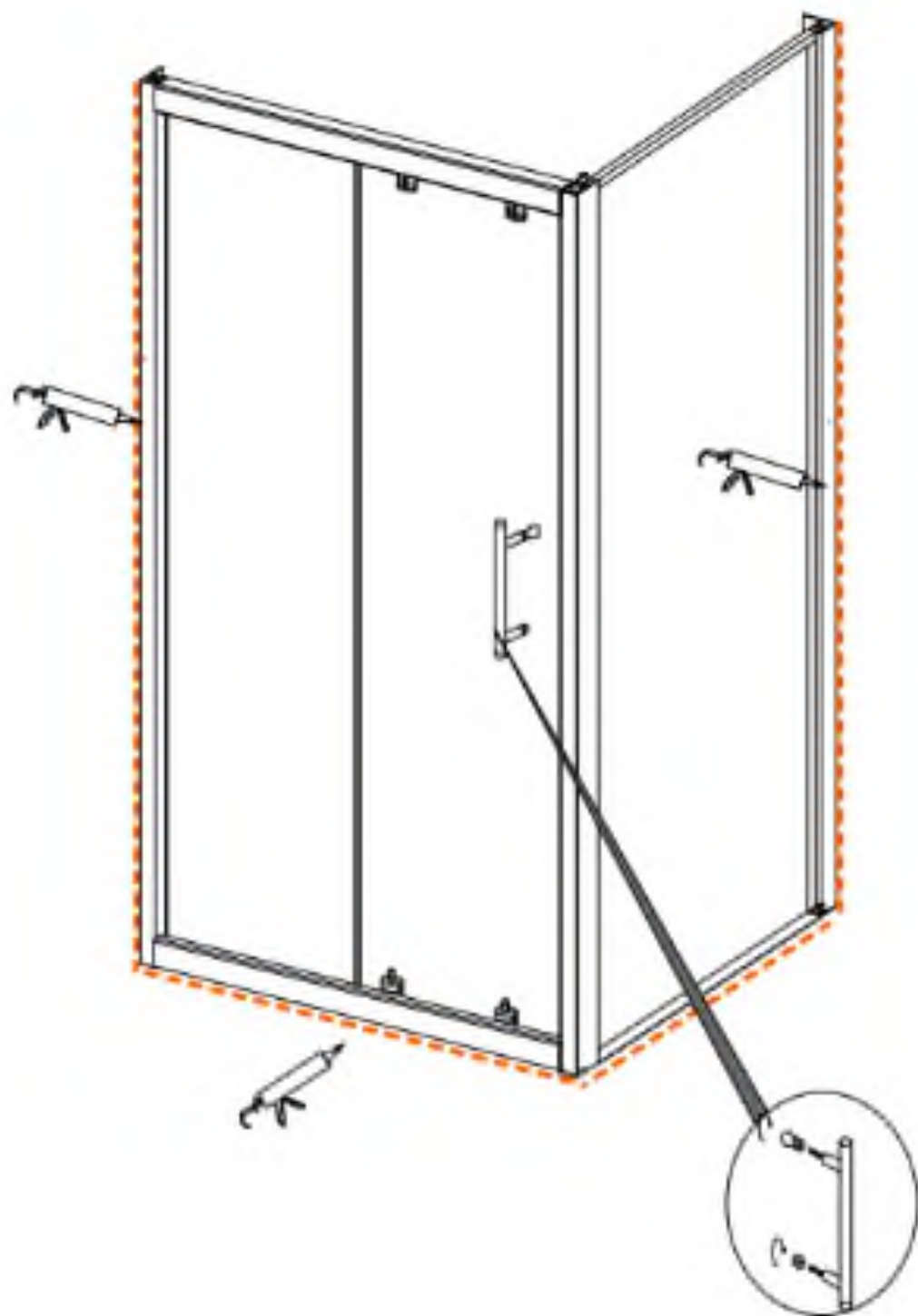



## Jótállási szelvény / Warranty card

<p><b>Jótállási jegy</b></p> <p>Vásárlás dátuma:.....</p> <p>Termék cikkszám: .....</p> <p>Üzembe helyezést végezte és annak időpontja:</p> <p>Csere indoka és annak időpontja:.....</p>	<p><b>Bélyegző, aláírás:</b></p>
<p><b>Warranty Card</b></p> <p>Date of purchase: .....</p> <p>Article Numbr:.....</p> <p>Installed by and date:.....</p> <p>Reason of exchange with date: .....</p>	<p><b>Stamp, signature:</b></p>